

1

2

3

4

5

6

A

A

B

B

C

C

D

D

E

E

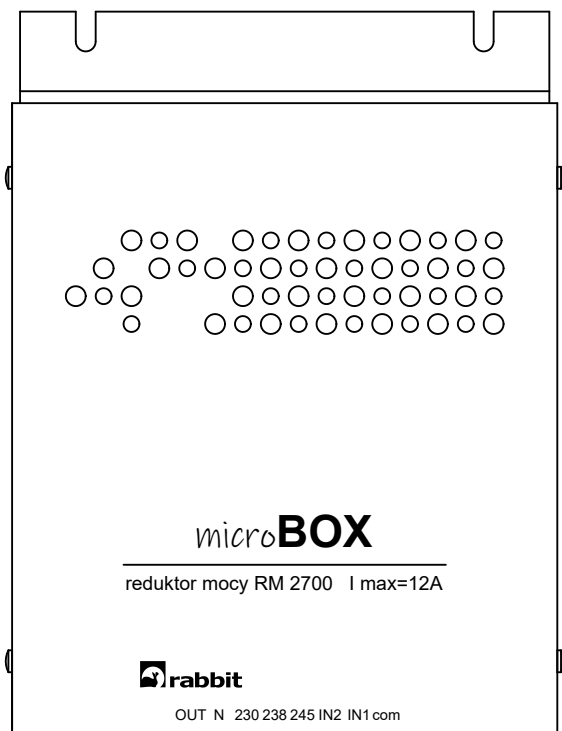

lighting power supply circuits

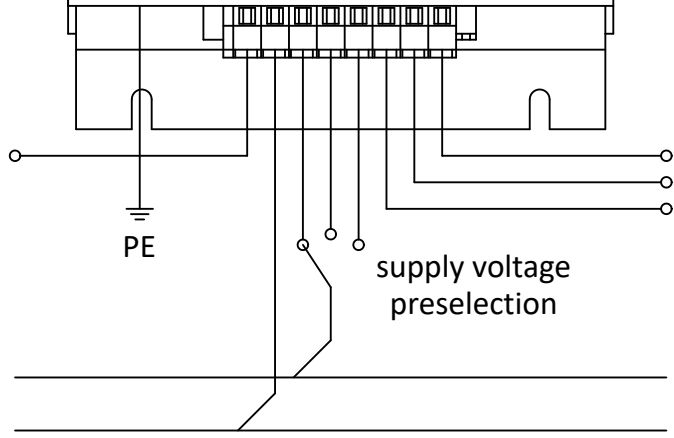

Timer (IN1 or IN2 short-circuit with COM)



**Rabbit Sp. z o.o.**  
 ul. Krakowska 141-155, 50-428 Wrocław  
 tel. +48 71 328 50 65  
 projekty@rabbit.pl  
 www.rabbit.pl

**microBOX 12A - power dimmer**

Wiring diagram

<b>microBOX 12A</b>	Page: 1 / 2	Date: 01.04.2022
---------------------	----------------	---------------------

	Scale: ---
--	---------------

1

2



3

4

5

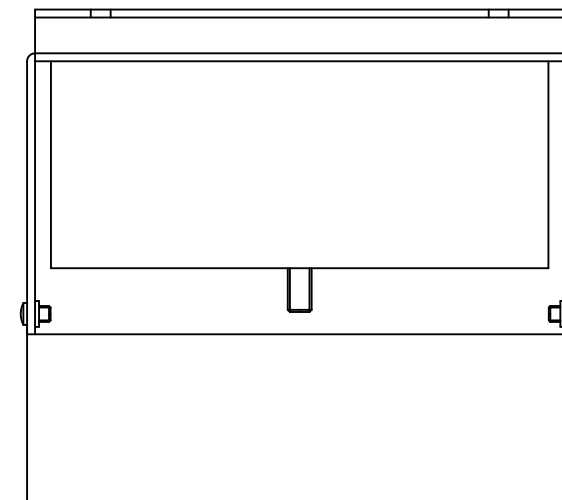
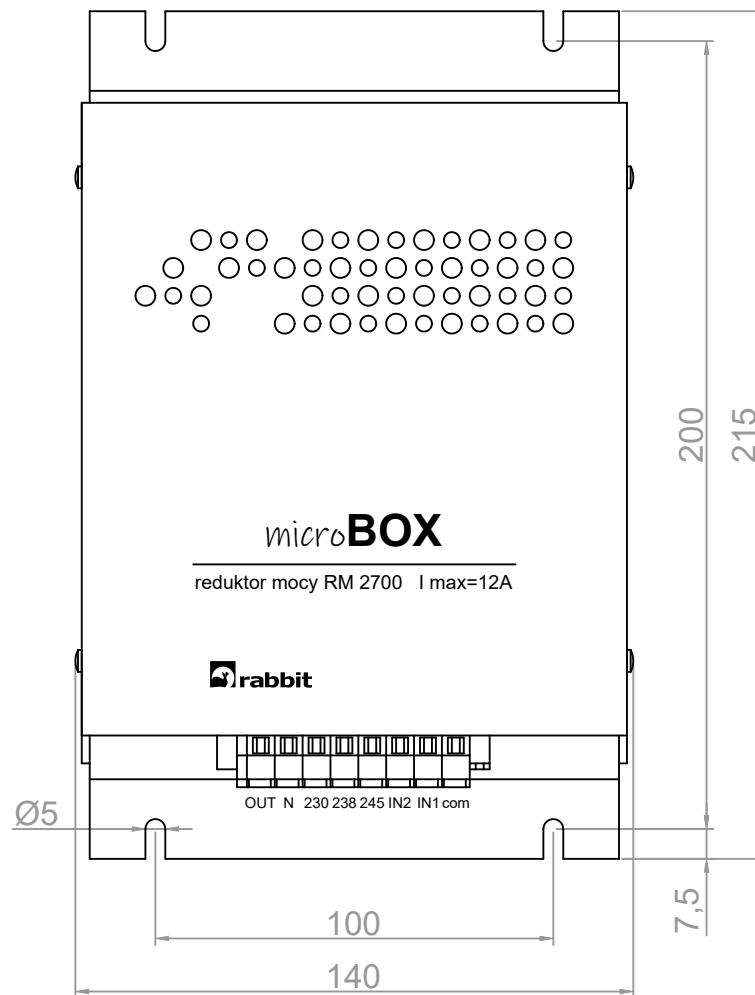
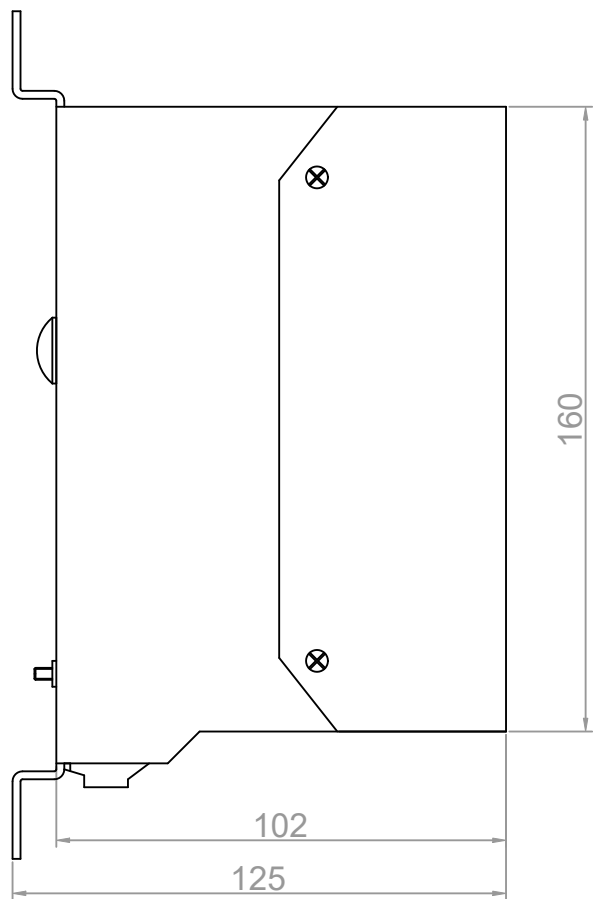
6



 <b>rabbit</b> SYSTEMY STEROWANIA OŚWIETLENIEM ULICZNYM	<b>microBOX 12A - power dimmer</b>			
	Rabbit Sp. z o.o. ul. Krakowska 141-155, 50-428 Wrocław tel. +48 71 328 50 65 projekty@rabbit.pl www.rabbit.pl	<b>microBOX 12A</b>	Page: 2 / 2	Date: 01.04.2022
	  DIN A4	Scale: 1:2		